

# Your 1<sup>st</sup> Choice in Lifts

## PRODUCT GENERAL DESCRIPTION

Nr	Description
1	Frame
2	Wall fittings
3	Landing door
4	Platform
5	Protective panel
6	Platform door
7	LOP
8	Magnet
9	Ramp

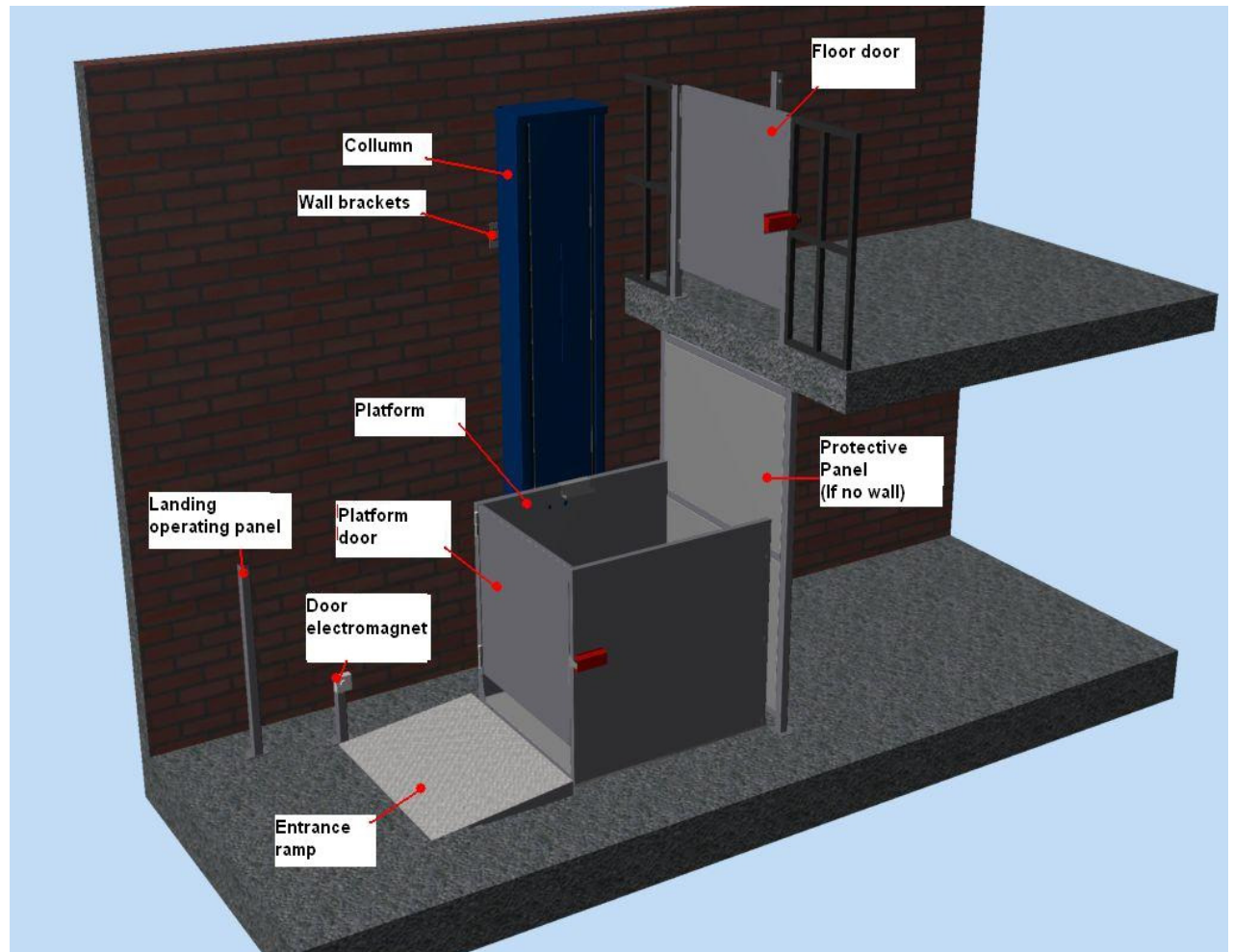

## TECHNICAL SPECIFICATIONS

TYPE	Hydraulic vertical transport system for disabled VERTIPLAT
Technical Specifications	
Max Rated load [Kg]	300
Persons	1+1
Travel [m]	7
Stops	3
Max speed [m/sec]	0,1
Min required length space [mm]	1050 (Standard 1270)
Min required width space [mm]	1240 (Standard 1400)
Min Pit depth [mm]	80 - Σε περίπτωση μηδενικού παρέχεται ράμπα αλουμινίου
Headroom [mm]	1550
Platform length [mm]	1000-1300 (Standard 1200)
Platform width [mm]	800-1000 (Standard 940)
Clear door opening [mm]	800-1000
Clear door height [mm]	1100
Guides	T75x62x10
Max fittings distance [mm]	2500
Piston	KZC50
Cylinder	76,1 x 4
Suspension	2:1
Type of chain	BL 523 (F = 40100Kp)
No of chain	2
Max pump supply [lit]	8
Rubber hoses diameter	3/8"
Block of valve	KV1 S 1/2"
Motor	1,5 Kw 1Φ

Safety system	
1	Stop under the platform (safety surface)
2	Semi automatic door with return spring and electromagnetic lock
3	Line rupture valve (poppet type)
4	Instantaneous safety gear for guide 10mm
5	Hold to run type buttons
6	Manual operated door with electromagnetic lock

for:

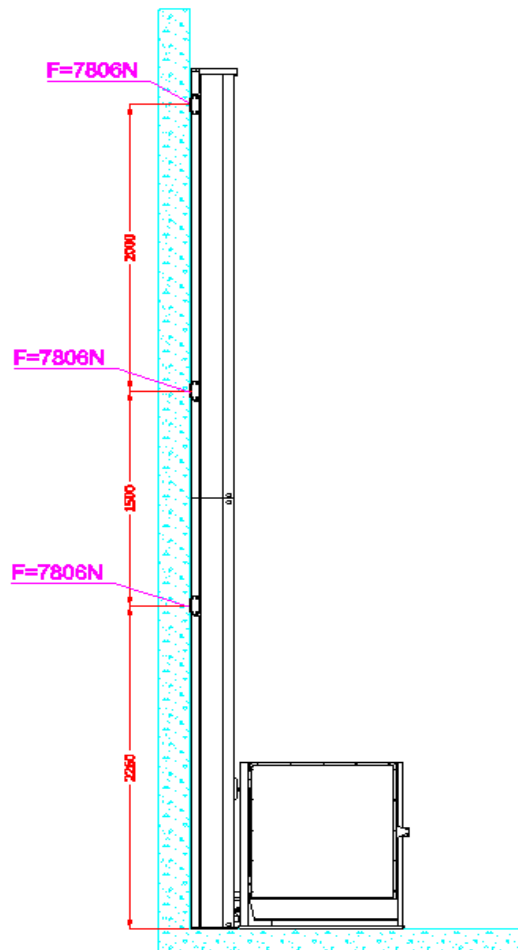

FORCES IN PIT  
max forces for 7m travel below of the pistons

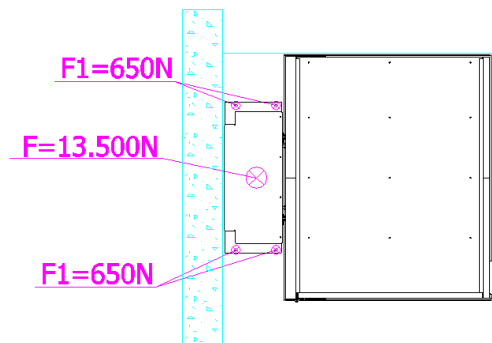

F = 7806N

F= 13500 N F=650N

## VERTIPLAT REQUIRED SHAFT DIMENSIONS

VERTIPLAT	
Space width	1240-1460
Space length	1070-1370
Min pit depth	80
Min headroom	1550

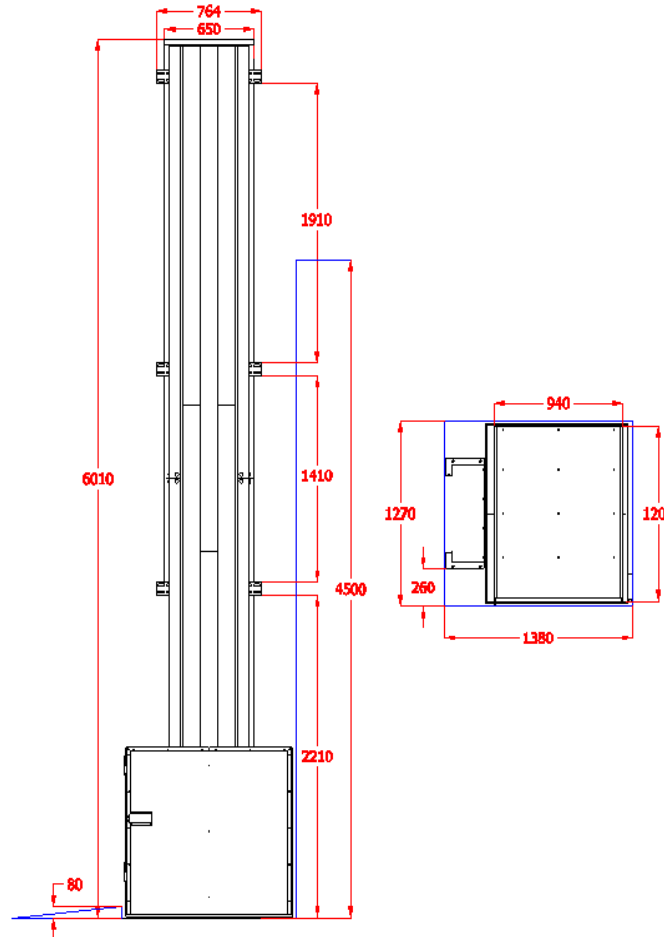

Vertiplat 1m Travel	
Fittings distance	1715
Vertiplat 2m Travel	
Fittings distance A	1215
Fittings distance B	1410
Vertiplat 3m Travel	
Fittings distance A	1715
Fittings distance B	2410
Vertiplat 4m Travel	
Fittings distance A	2215
Fittings distance B	1410
Fittings distance C	1910
Vertiplat 4,5m Travel	
Fittings distance A	2215
Fittings distance B	1410
Fittings distance C	1910
Vertiplat 5m Travel	
Fittings distance A	1715
Fittings distance B	410
Fittings distance C	1910
Fittings distance D	410
Fittings distance C	1410
Vertiplat 6m Travel	
Fittings distance A	1715
Fittings distance B	410
Fittings distance C	1910
Fittings distance D	410
Fittings distance C	1910
Vertiplat 7m Travel	
Fittings distance A	2215
Fittings distance B	410
Fittings distance C	910
Fittings distance D	1910
Fittings distance E	410
Fittings distanceZ	1910

## Platform cases

Case A (Standard)	
Ground floor	Platform door
Floor	Landing door

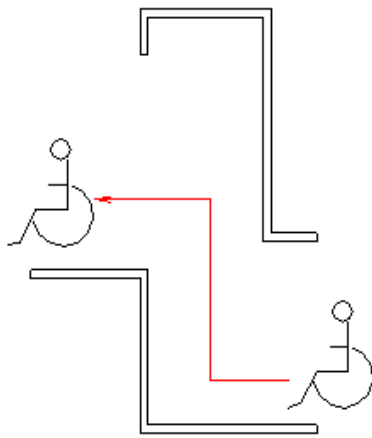
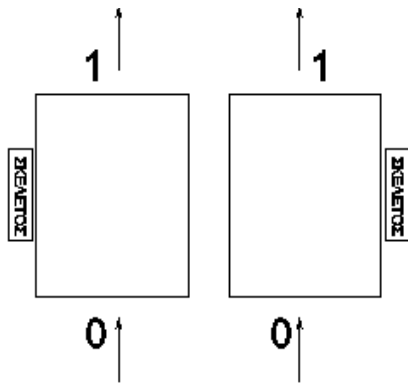

Case B (Optional)	
Ground floor	Landing door
Floor	Landing door
Platform	Μπάρα

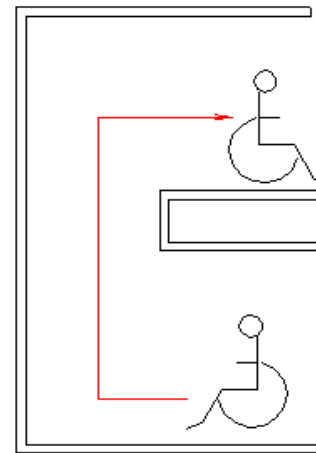
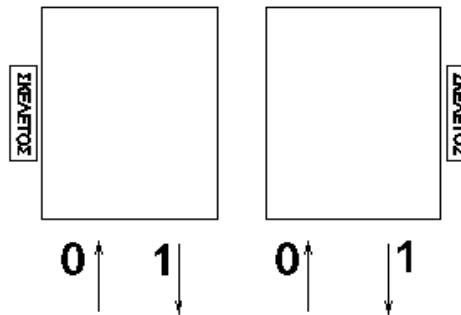

Case C (Optional)	
Ground floor	Platform door
Floor	Landing door

